

equation

2
YEARS
GUARANTEE*

YCD02-5 / YCD02-7
YCD02-9 / YCD02-11

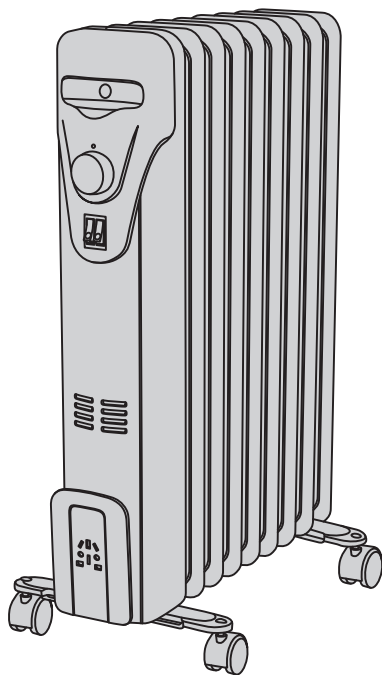

- FR Notice de Montage - Utilisation - Entretien
- ES Instrucciones de Montaje, Utilización y Mantenimiento
- PT Instruções de Montagem, Utilização e Manutenção
- IT Istruzioni per il Montaggio, l'Uso e la Manutenzione
- EL Εγχειρίδιο συναρμολόγησης, χρήσης και συντήρησης
- PL Instrukcja Montażu, Użytkowania i Konserwacji
- RO Manual asamblare, utilizare și întreținere
- EN Assembly - Use - Maintenance Manual

EAN CODE

YCD02-5 3276000370574 / 3276000380047

YCD02-7 3276000370581 / 3276000380054

YCD02-9 3276000370598 / 3276000380061

YCD02-11 3276000370604 / 3276000380078

Traduction de la version originale du mode d'emploi - Radiateur bain d'huile / Traducción de las Instrucciones originales - Radiador de aceite / Tradução das Instruções Originais - Radiador a óleo / Traduzione delle istruzioni originali - Radiatore elettrico a olio / Μετάφραση των πρωτότυπων οδηγιών - Καλοριφέρ λαδιού / Tłumaczenie instrukcji oryginalnej - Grzejnik olejowy / Traducerea instrucțiunilor originale - Radiator cu ulei / Original Instructions - Oil heater



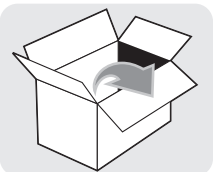

YCD02-5

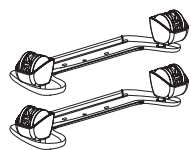

B *2



C *1

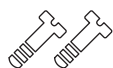

D *2

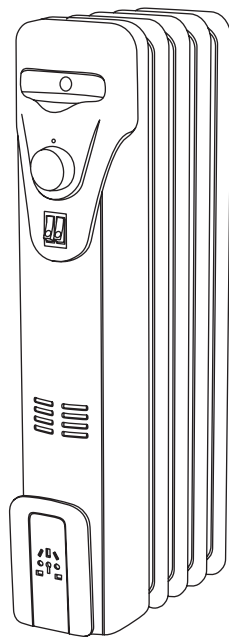

A *1

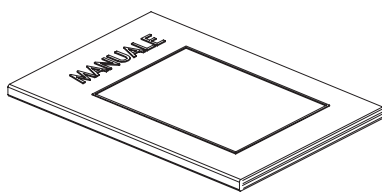

E *1

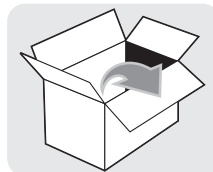

YCD02-7

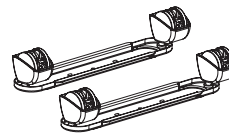

B *2



C *1



D *2

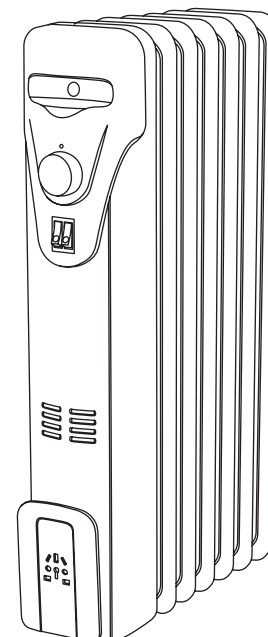

A *1

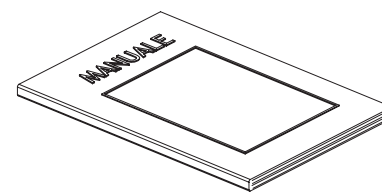

E *1

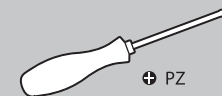
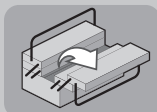
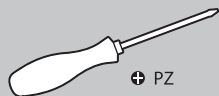
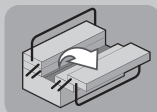

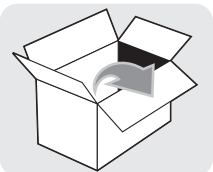

YCD02-9

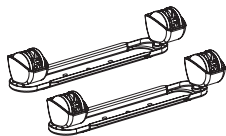
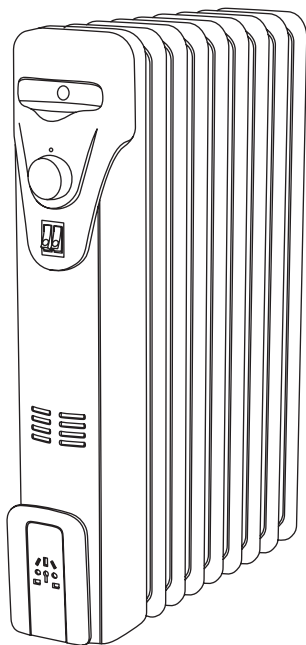

B *2



C *1

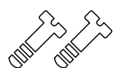

D *2

A *1

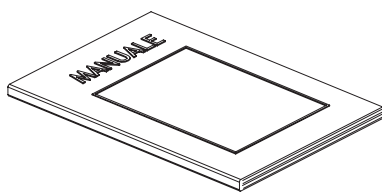

E *1

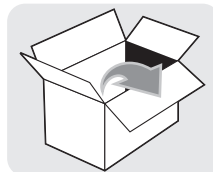

YCD02-11

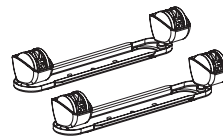
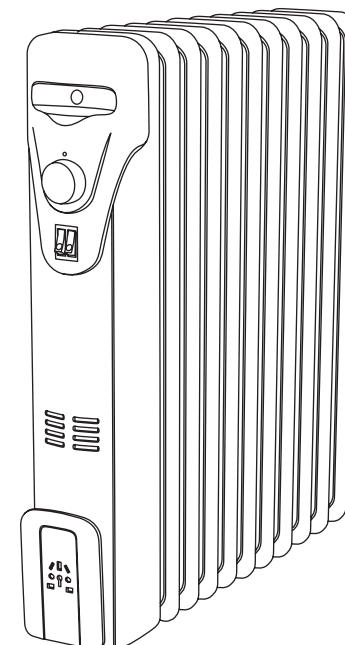

B *2



C *1



D *2

A *1

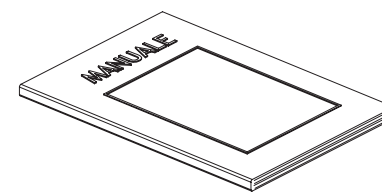

E *1

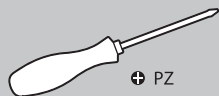
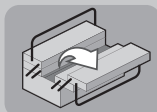

PZ



4

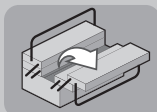

PZ



5

 Attention danger / Atención: Peligro / Atencão perigo / Attenzione pericolo / Προσοχή κίνδυνος / Uwaga niebezpieczeństwo / Внимание! Опасно! / Увага! Небезпечно! / Atenție, pericol / Caution danger

 Observez / Atención / Aviso / Osservare / Προσέξτε / Przestrzegać / Соблюдайте правила техники безопасности / Дотримуйтеся правил техніки безпеки / Respectați / Observe

 Raccordé / Conectado / Ligado / Connesso / Με σύνδεση / Podłączone / Подключено / Під'єднано / Conectat / Connected

 Hors tension / Araigado / Desligado da alimentação / Fuori tensione / Εκτός τάσης / Odłączenie zasilania / Не под напряжением / Не під напругою / Scoatere de sub tensiune / Power off

 Mise sous tension / Puesta en tensión / Ligação da alimentação / Messo sotto tensione / Σύνδεση με το ηλεκτρικό δίκτυο / Włączenie zasilania / Включение под напряжение / Під'єднання під напругу / Punere sub tensiune / Power up

 Nettoyage / Limpieza / Limpeza / Pulizia / Καθαρισμός / Czyszczenie / Чистка / Очищення / Curățare / Cleaning

 Correct / Correcto / Correcto / Corretto / Σωστό / Dobrze / Правильный / Правильно / Corect / Correct

 Incorrect / Incorrecto / Incorrecto / Errato / Λάθος / Źle / Неправильный / Неправильно / Incorect / Incorrect

 Mentions légales & consignes de sécurité / Instrucciones legales y de seguridad / Avisos legais e instruções de segurança / Istruzioni legali e di sicurezza / νομικό σημείωμα και οδηγίες ασφαλείας / uwagi prawne i instrukcja bezpieczeństwa / руководство по технике Безопасности и правовым нормам / керівництво з техніки безпеки і правовим нормам / manual privind siguranța și aspectele juridice / Legal & safety instructions

Notes / Observaciones / Notas / Note /
Σημειώσεις / Notatki / Примечания /
Примітки / Note / Notes

1

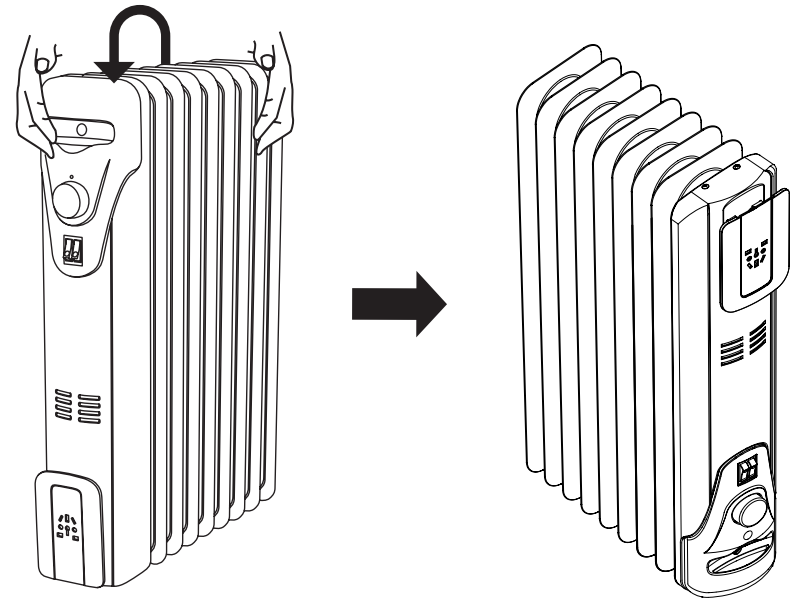

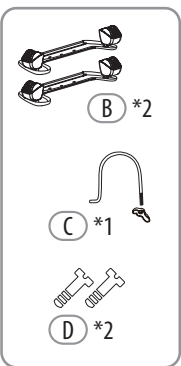

YCD02-5

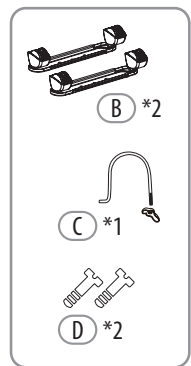
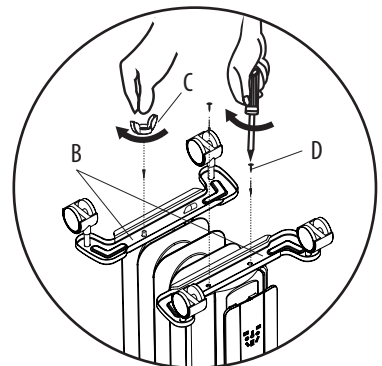
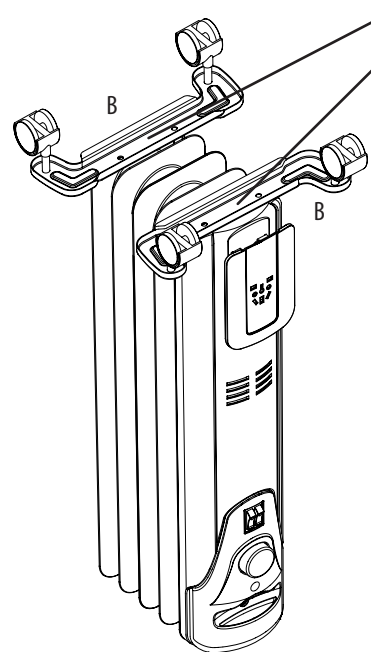
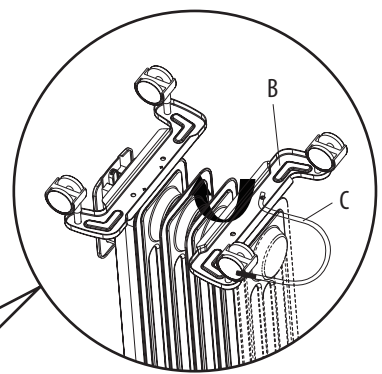

YCD02-7
YCD02-9
YCD02-11

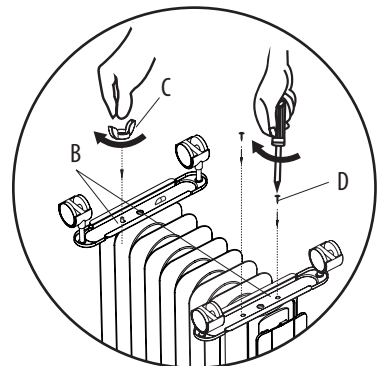
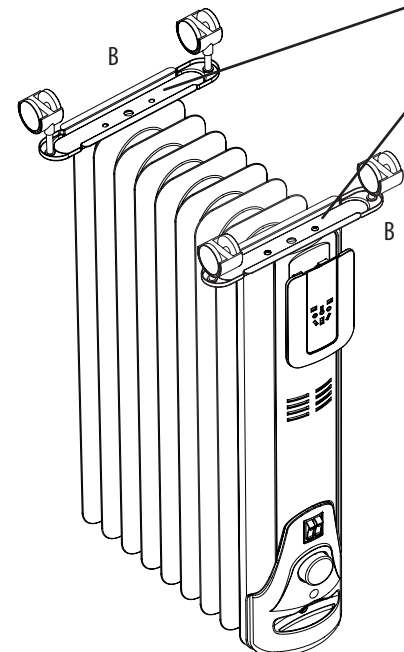
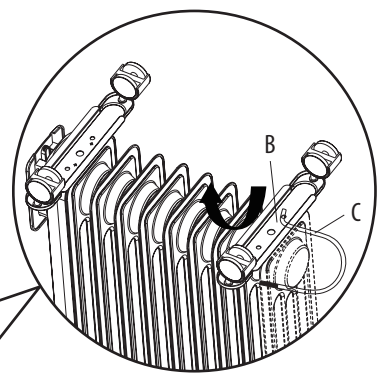

A

FR Montage

ES Montaje

PT Montagem

IT Montaggio

EL Συναρμολόγηση

PL Montaż

RO Montaj

EN Assembly

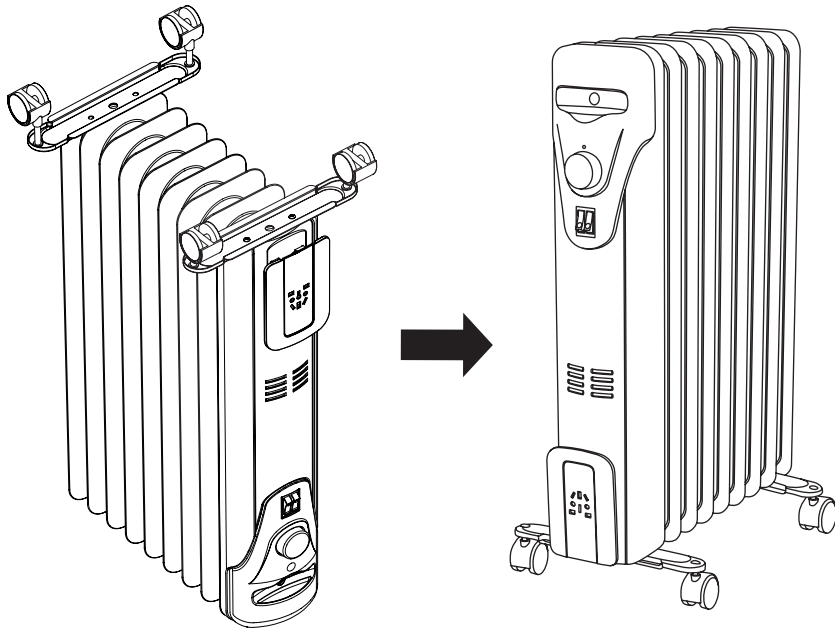
3

FR Utilisation

ES Utilización

PT Utilização

IT Uso

EL Χρήση

PL Użytkowanie

RO Utilizare

EN Use

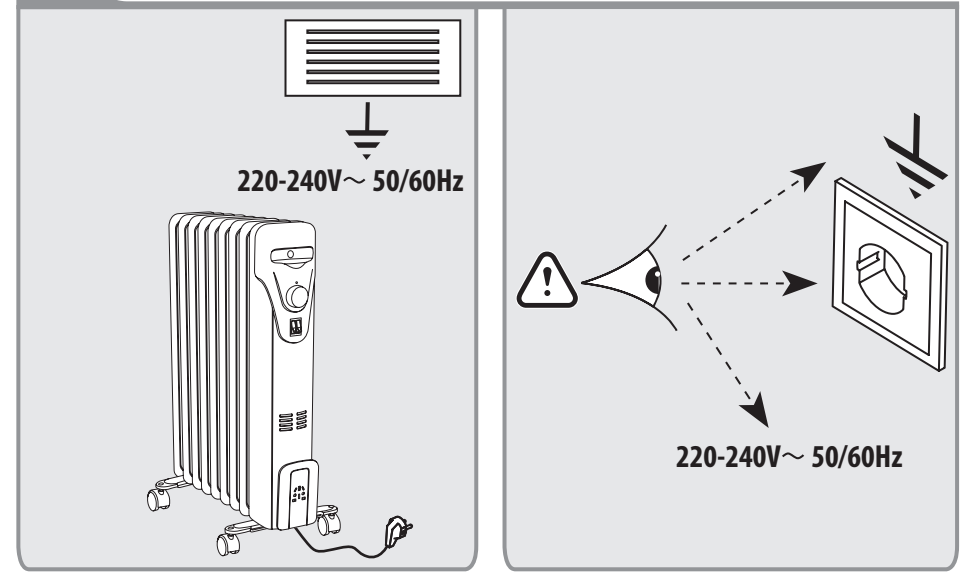
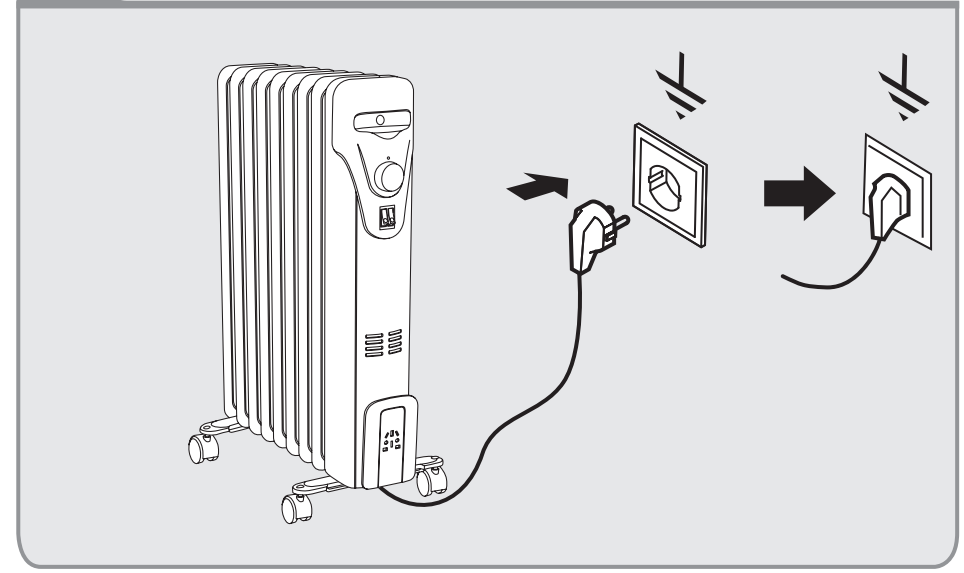
B**1****2**

3

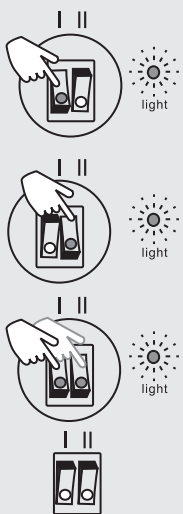
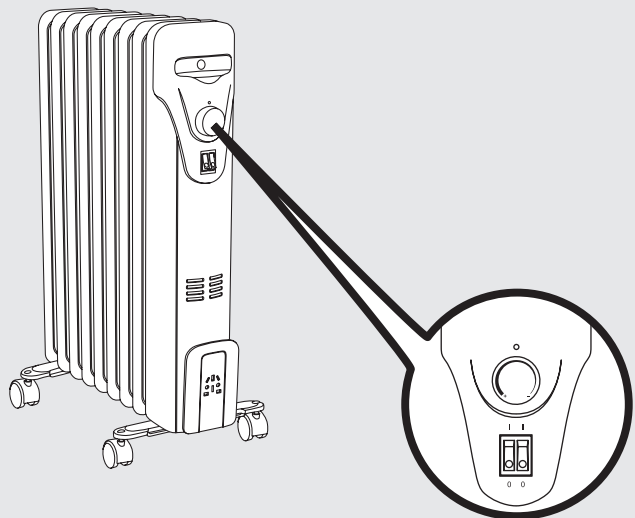

	YCD02-5	YCD02-7	YCD02-9	YCD02-11
I II	I 400W	I 600W	I 800W	I 1000W
I II	II 600W	II 900W	II 1200W	II 1500W
I II	I+II 1000W	I+II 1500W	I+II 2000W	I+II 2500W
I II	STOP	STOP	STOP	STOP

4

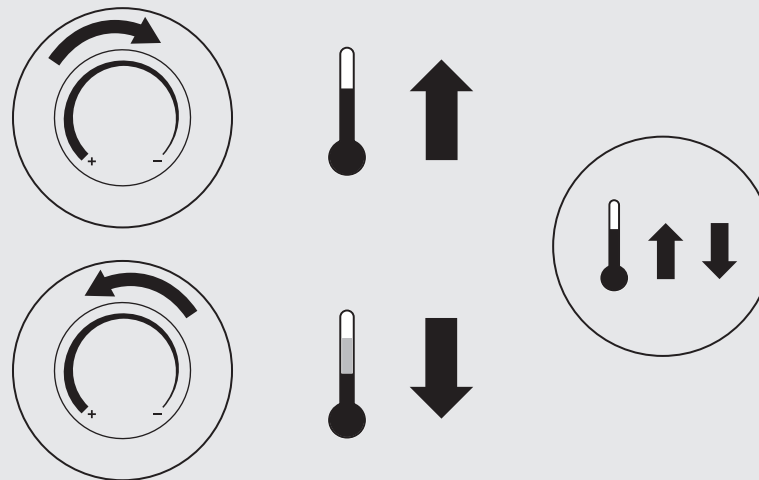

5

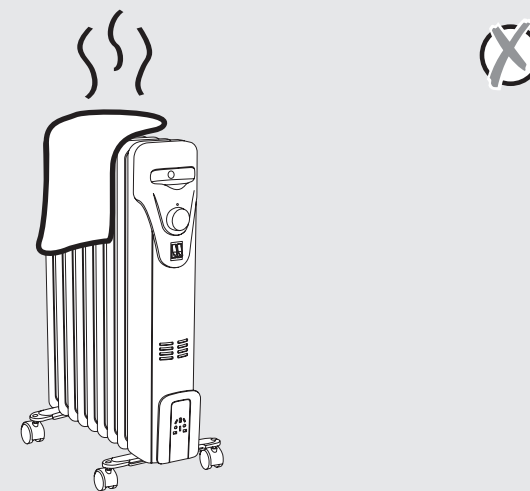

B

FR Utilisation ES Utilización PT Utilização IT Uso
 EL Χρήση PL Użytkowanie RO Utilizare EN Use

6

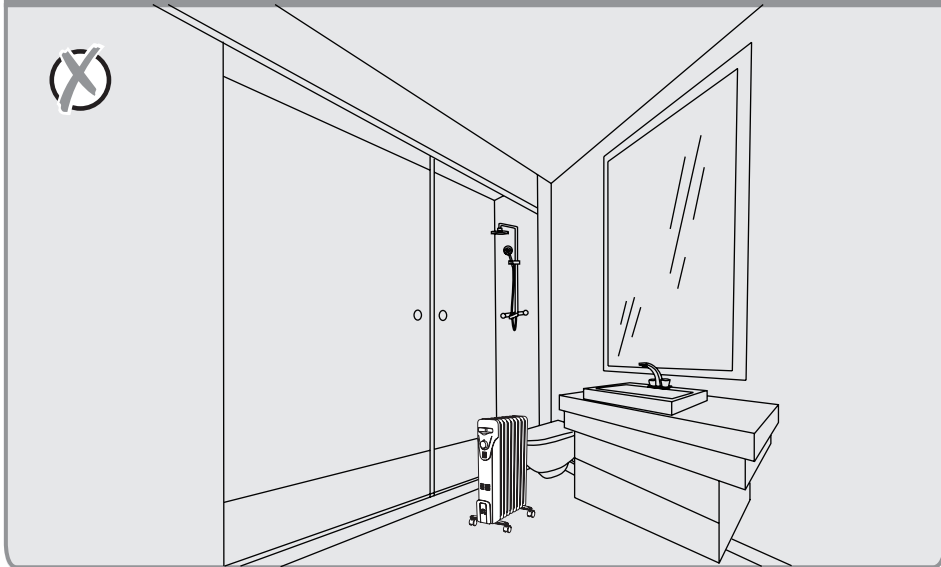

7

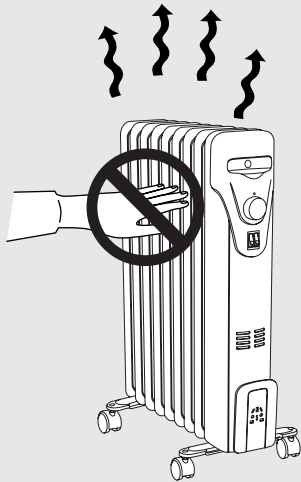

FR Utilisation ES Utilización PT Utilização IT Uso
 EL Χρήση PL Użytkowanie RO Utilizare EN Use

B

8

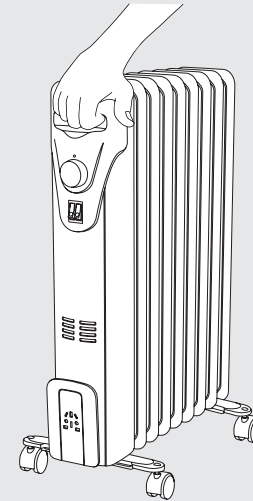

9

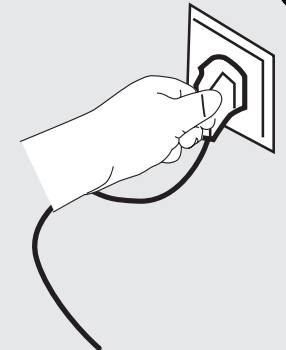
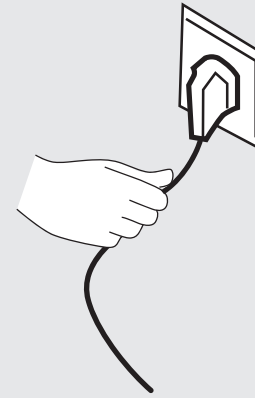

1

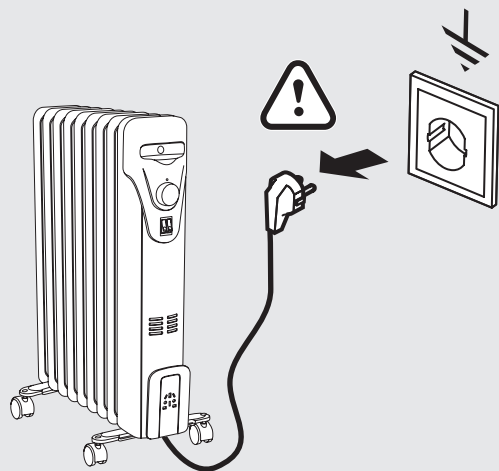
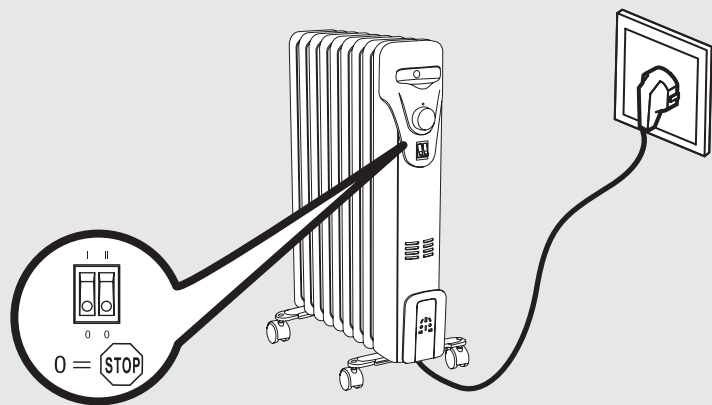

2



15 min.

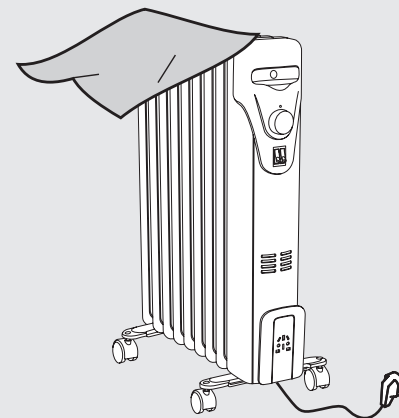

3

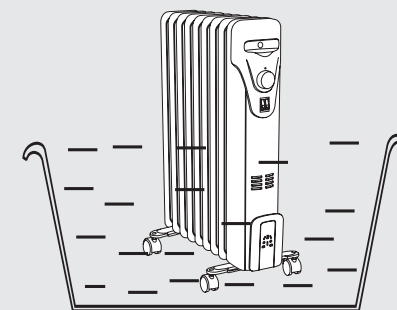
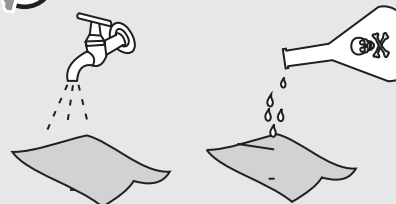
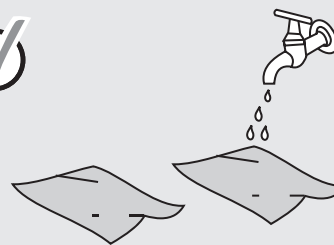

CFR Entretien
EL ΣυντήρησηES Mantenimiento
PL KonserwacjaPT Serviço
RO ÎntreținereIT Manutenzione
EN Maintenance

4

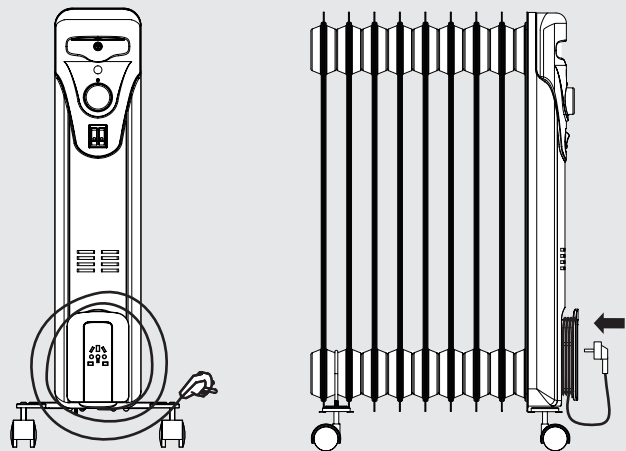

5

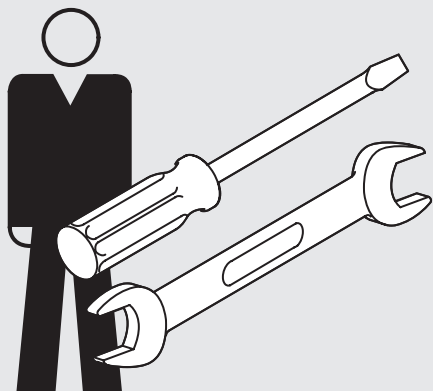

FR Hivernage

ES Durante el invierno

PT Preparação para o inverno

IT Rimessaggio

EL Αποθήκευση το χειμώνα

PL Przechowywanie

RO Păstrare pe perioada iernii

EN Winter storage

D

1

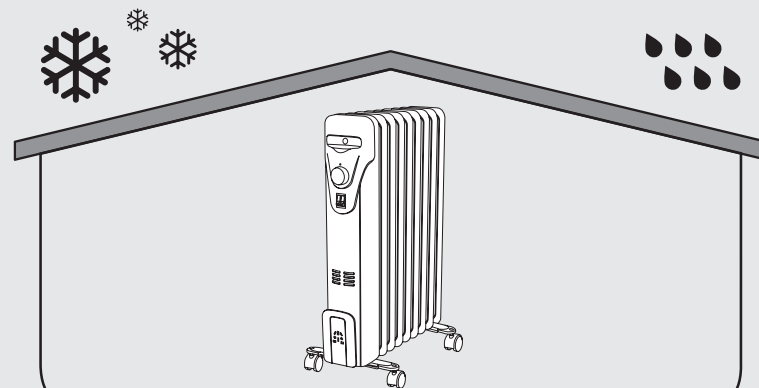

* Garantie 2 ans / 2 años de garantía / Garantia de 2 anos /
Garanzia 2 Anni / Εγγύηση 2 ετών / Gwarancja 2-letnia / Гарантия 2 года /
Гарантія 2 років / Garanție 2 ani / 2-years guarantee



FR ADEO Services - 135 Rue Sadi Carnot - CS 00001
59790 RONCHIN - France

RU ООО ЛЕРУА МЕРЛЕН ВОСТОК, 141031, Московская область,
Мытищинский район, г. Мытищи, Осташковское шоссе,
д.1, РОССИЯ

UA ТОВ «Леруа Мерлен Україна»,
вул. Полярна 17а, м. Київ 04201, Україна

Made in P.R. C. 2018

